

Sort[®]

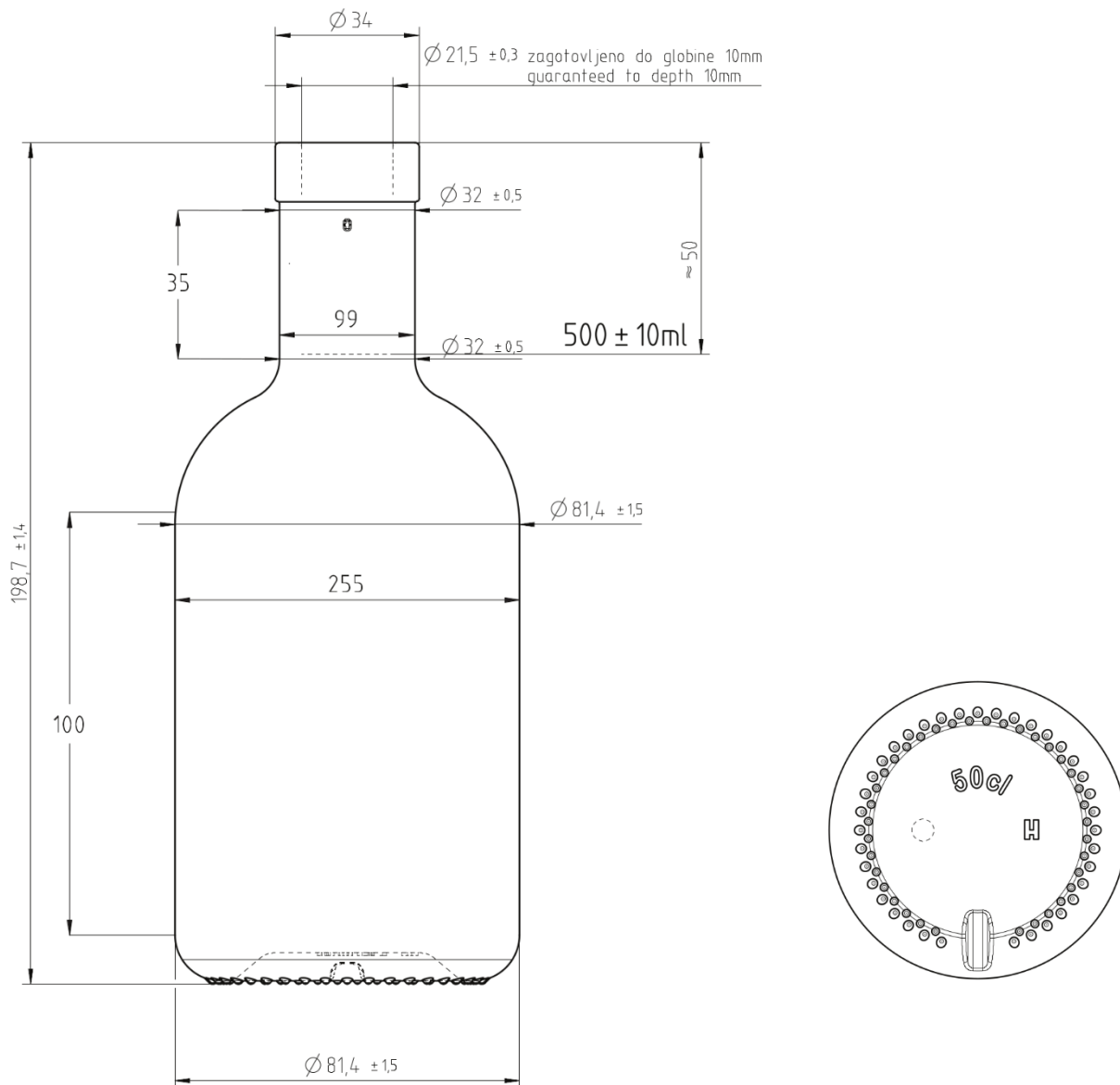

Apollo 500 ml



Dane techniczne / Technical data		Schemat pakowania / Packing data	
Waga butelki / Bottle weight	~490 g	Wymiar palety / Pallet dimensions	120x100
Zamknięcie / Mouthpiece	Cork	Ilość sztuk na palecie / Units per pallet	1540
Kolor szkła / Glass colour	Extra white flint	Waga palety / Pallet weight	815 kg