

*Sort*<sup>®</sup>

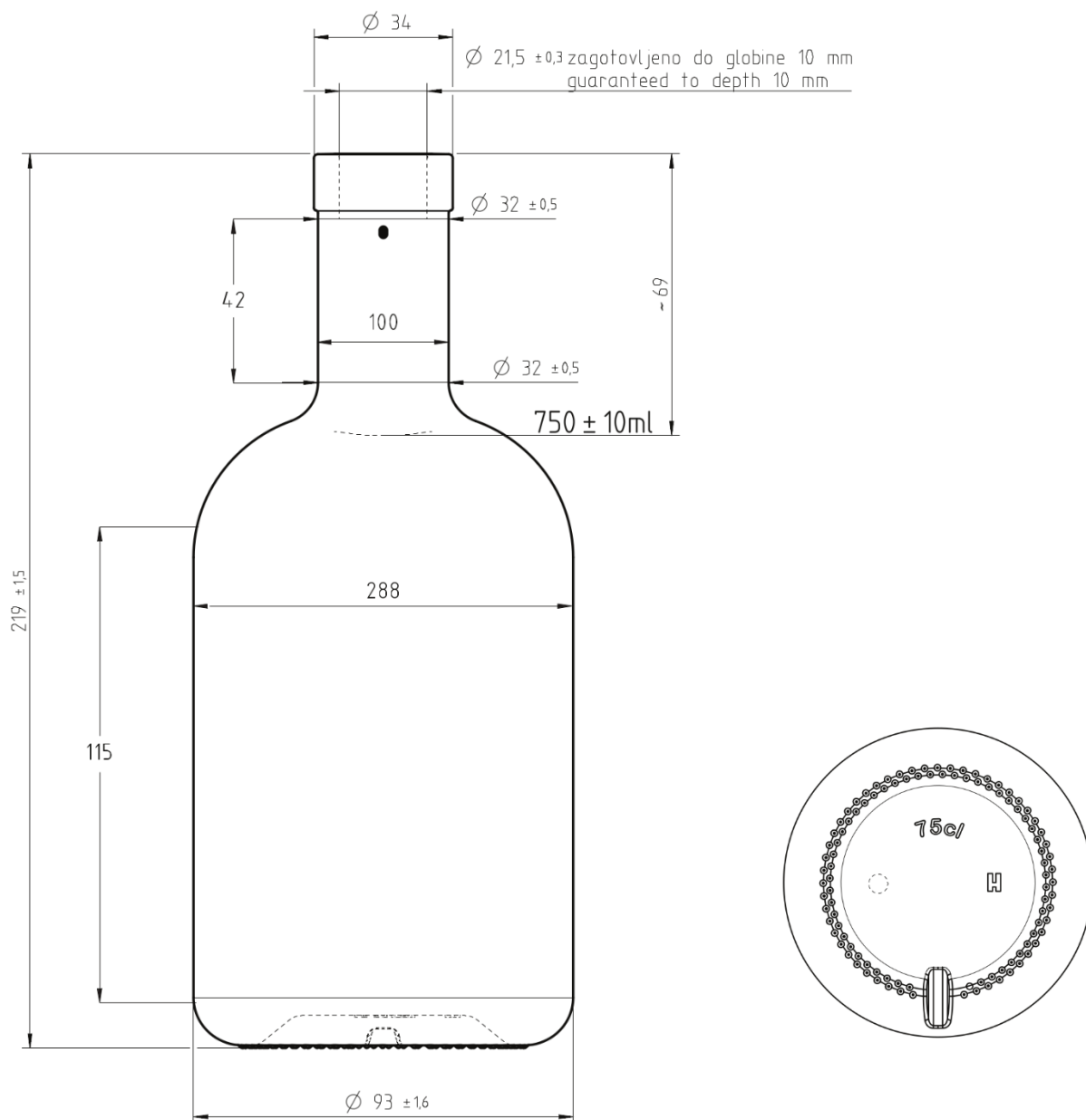

## Apollo 750 ml



Dane techniczne / Technical data		Schemat pakowania / Packing data	
Waga butelki / Bottle weight	~575 g	Wymiar palety / Pallet dimensions	120x100
Zamknięcie / Mouthpiece	Cork	Ilość sztuk na palecie / Units per pallet	1080
Kolor szkła / Glass colour	Extra white flint	Waga palety / Pallet weight	688 kg