

*Sort*<sup>®</sup>

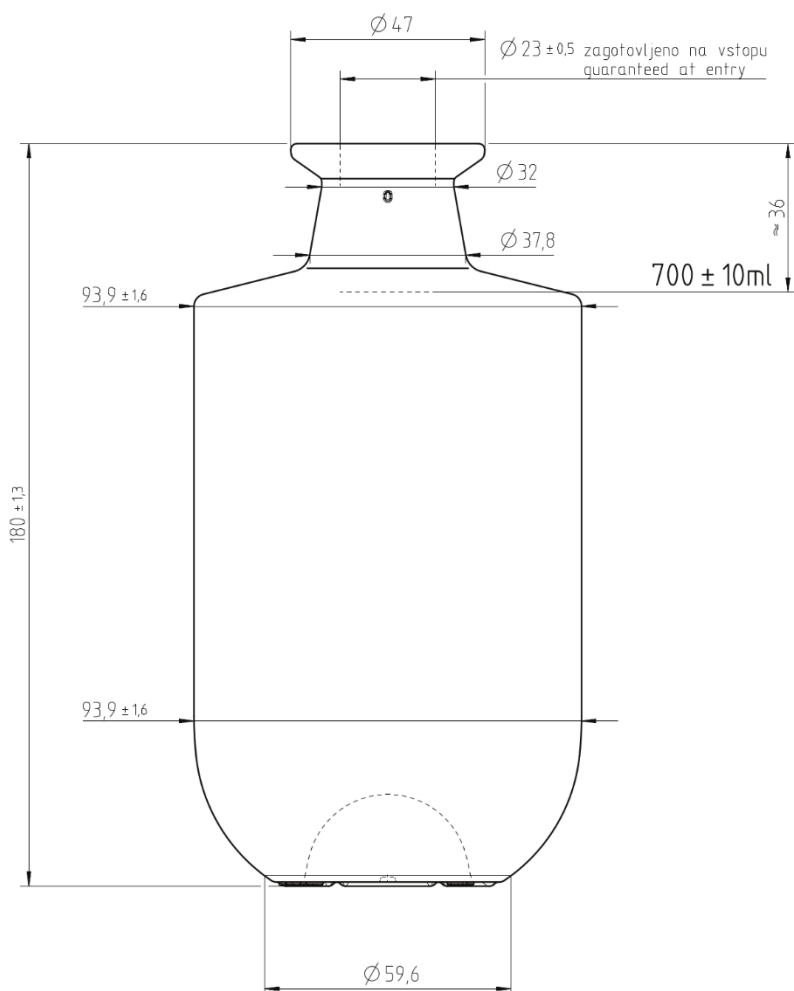

## Lyra 700 ml

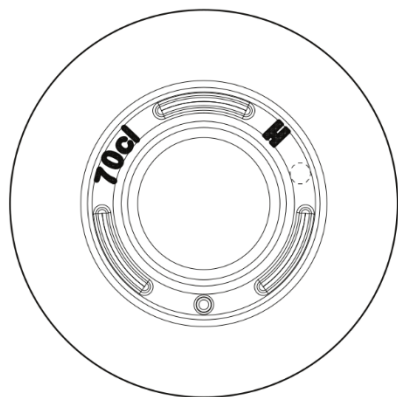

Dane techniczne / Technical data		Schemat pakowania / Packing data	
Waga butelki / Bottle weight	~600 g	Wymiar palety / Pallet dimensions	120x100
Zamknięcie / Mouthpiece	BP Carnette	Ilość sztuk na palecie / Units per pallet	1200
Kolor szkła / Glass colour	Extra white flint	Waga palety / Pallet weight	760 kg